

LD22



High power 24V Linear LED cove light

Data sheet - Page 1



Design: Maurice Brill Lighting Project: 20 Fenchurch Street Product: LD22

LD22 is a very small, low profile linear system. Designed to maximise the light output with a broad beam, it is ideal for coves, shelf details, recesses and highlighting architectural details. It is a 24V DC system allowing long lengths to be powered from a single driver.

Key Features

- Choice of LED outputs depending on the application including RGB + tunable white
- Very low profile
- Clear cover is supplied as standard. A frosted diffuser can be specified, creating a softer light effect which can be useful in tight details
- A range of fixing options including a miniature adjustable bracket allows maximum flexibility
- IP40 as standard with an IP54 option for pool/spa coffers (not exterior applications)
- Lengths are custom made to suit to a maximum of 3014mm, so no dark spots!
- Short pieces can be made interlinked to accommodate curves
- Available with Switched, 1-10V, DMX or Dali drivers

Dimensions

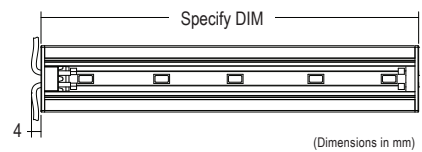
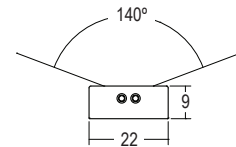

LD22



High power 24V Linear LED cove light

Data sheet - Page 2

LED output options	LG500 500 lm/m		LG1200 1200 lm/m		LG2000 2000 lm/m		RGB 435 lm/m	TW2000 2000lm/m
Applications								
Description	500 lm tape		1200lm tape		2000lm tape		RGB tape	Colour change
Colour Temperature	2200K / 2500K / 2700K	3000K / 4000K	2000K / 2400K / 5000K	2700K / 3000K / 4000K	2000K / 2400K / 5000K	2700K / 3000K / 4000K	-	2700K + 6500K
CRI	80+		80+	90+	80+	90+	-	80+
Delivered lumens / m	480lm/m	520lm/m	1200lm/m		2000lm/m		435 lm/m	2000lm/m
Watts / m	3.9W/m		10.4W/m		18W/m		18W/m	18.5W/m
Lumens per watt	128lm/w		113lm/w		111lm/w		24.1 lm/w	108lm/w
LED cut increments	100mm		100mm		100mm		100mm	75mm
LED spacing	14.3mm		14.3mm		14.3mm		25mm	12.5mm
Min single length	114mm		114mm		114mm		114mm	89mm
Max single length**	3014mm							
LED	Osram Flex							
Voltage (V)	24V DC							
LED lifetime	50,000hrs (to 70% lumen output)							
Max ambient Temperature	45°C							
Materials	Silver anodised aluminium extrusion with ABS plastic end caps. Stainless fixing clips. Anodised aluminium brackets.							
IP rating	IP40 as standard (IP54 option for pool/spa applications - not for exterior use)							

* Shipping and practicalities of installation need to be considered when specifying long lengths

Fixing Options

/SC - Spring clip fixing

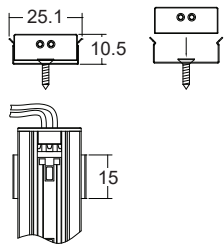

/BEM - Bracket end mounting (Max 1000mm)

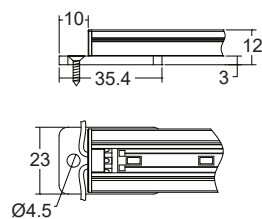

/BSM - Bracket side mounting

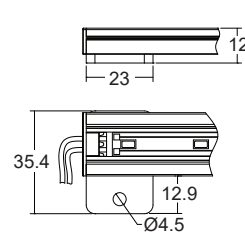

/ABM - Adjustable bracket mounting

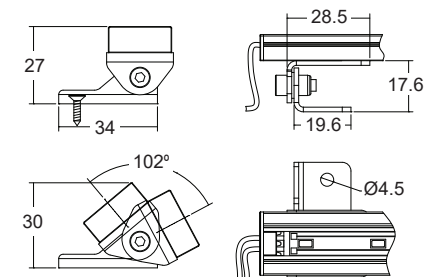

(Dimensions in mm)

LD22

High power 24V Linear LED cove light



Data sheet - Page 3



Project: Private Residence
Design: Spectron
Product: LD22

Linked sections

LD22 can be linked to allow for curves. The length of each module depends on the LED used and the radius of the curve.

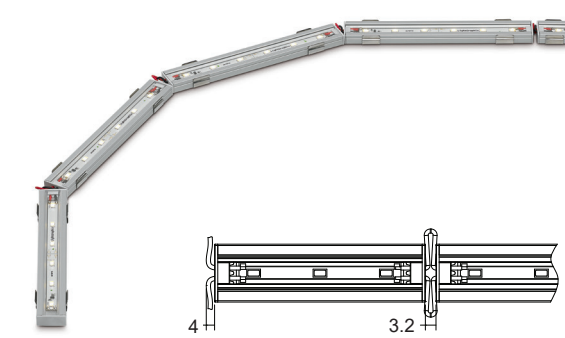

Cover options

Frosted cover diffuses the light source and softens the beam edges

/CC - Clear cover

/FC - Frosted cover



LD22

High power 24V Linear LED cover light



Data sheet - Page 4



Photometrics

Photometric files are included in the design pack which can be downloaded from the LD22 product page on the website.

Order Codes and Options

Product code	LED	LED colour	Cover	Fixing option	IP rating	Length
LD22						

Example: LD22 / LG1200 / LW30 / CC / SC / IP40 / 2000mm

LED output options		Suffix
LG500	500 lm/m	/LG500
LG1200	1200 lm/m	/LG1200
LG2000	2000 lm/m	/LG2000
RGB	475 lm/m	/RGB
TW2000	2000 lm/m	/TW2000
LED colour options		
LG500	Candle White - 2200K	/LW22
	Super Warm White - 2500K	/LW25
	Extra Warm White - 2700K	/LW27
	Warm White - 3000K	/LW30
	White - 4000K	/LW40
LG1200 + LG2000	Candle White - 2000K	/LW20
	Super Warm White - 2400K	/LW24
	Extra Warm White - 2700K	/LW27
	Warm White - 3000K	/LW30
	White - 4000K	/LW40
TW2000	Cool White - 5000K	/LW50
	Tunable White - 2700K + 6500K	/LW27 + /LW65
Cover options		
Clear Cover		/CC
Frosted Cover		/FC
Fixing options		
Spring Clips		/SC
Bracket end mounting (Max 1000mm)		/BEM
Bracket side mounting		/BSM
Adjustable bracket mounting		/ABM
IP options		
IP40 (internal use as standard)		/IP40
IP54 rated for moist environments (not for exterior use)		/IP54

To be used with 24V constant voltage LED Drivers and Controllers

We offer a range of drivers with 1-10V, DMX, and DALI dimming options. Please download the data sheet from the downloads section at www.lightgraphix.co.uk, or contact us for more information